



# LED Display Product Data Sheet LTJ-811G

Spec No.: DS-30-96-298

Effective Date: 06/01/2001

Revision: -

**LITE-ON DCC**

**RELEASE**

BNS-OD-FC001/A4

**FEATURES**

- \* 0.8 inch (20.0 mm) DIAMETER BIG LAMP.
- \* WIDE VIEWING ANGLE.
- \* GRAPHIC STACKING ALLOWABLE.
- \* HIGH LUMINOUS INTENSITY.
- \* LOW POWER REQUIREMENT.
- \* SOLID STATE RELIABILITY.
- \* CATEGORIZED FOR LUMINOUS INTENSITY.
- \* EXCELLENT ON-OFF CONTRAST.
- \* SUITABLE FOR MULTIPLEX OPERATION.
- \* EASY MOUNTING ON P.C. BOARD OR SOCKETS.

**DESCRIPTION**

The LTJ-811G big lamp is sphere light sources designed for a variety of application where a large, right source of light is required. The ultra green device utilize LED chips which are made from GaP on a transparent GaP substrate. The ultra green devices have green diffused lens color.

**DEVICE**

<b>PART NO.</b>	<b>DESCRIPTION</b>
GREEN	Universal
LTJ-811G	Sphere lens

## PACKAGE DIMENSIONS

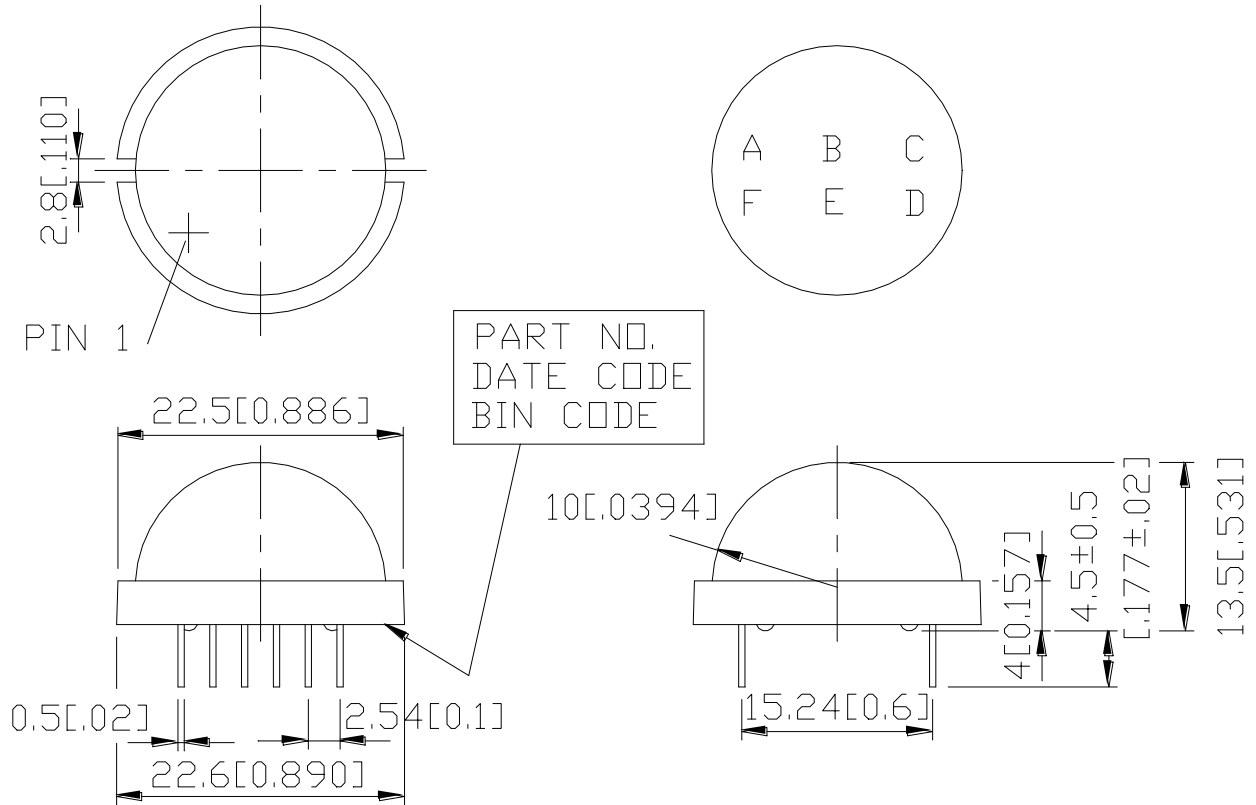

NOTES: All dimensions are in millimeters. Tolerances are ± 0.25 mm (0.01“) unless otherwise noted.

## INTERNAL CIRCUIT DIAGRAM

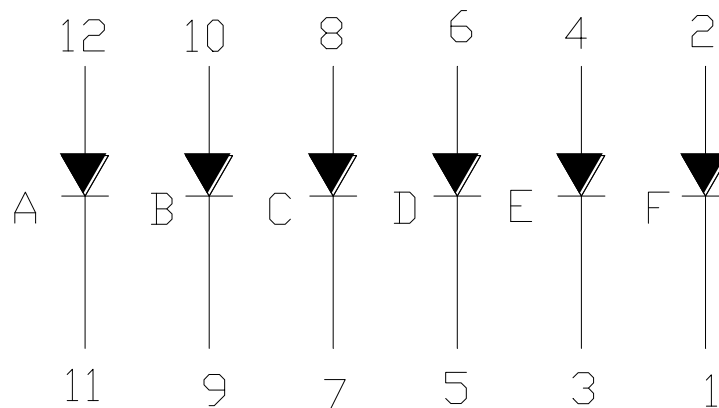

**PIN CONNECTION**

<b>No.</b>	<b>CONNECTION</b>
1	CATHODE F
2	ANODE F
3	CATHODE E
4	ANODE E
5	CATHODE D
6	ANODE D
7	CATHODE C
8	ANODE C
9	CATHODE B
10	ANODE B
11	CATHODE A
12	ANODE A

**ABSOLUTE MAXIMUM RATING AT Ta=25°C**

PARAMETER	MAXIMUM RATING	UNIT
Power Dissipation Per Segment	75	mW
Peak Forward Current Per Segment ( 1/10 Duty Cycle, 0.1ms Pulse Width )	100	mA
Continuous Forward Current Per Segment	25	mA
Derating Linear From 25°C Per Segment	0.33	mA/°C
Reverse Voltage Per Segment	5	V
Operating Temperature Range	-35°C to +85°C	
Storage Temperature Range	-35°C to +85°C	
Solder Temperature: max 260°C for max 3sec at 1.6mm[1/16inch] below seating plane.		

**ELECTRICAL / OPTICAL CHARACTERISTICS AT Ta=25°C**

PARAMETER	SYMBOL	MIN.	TYP.	MAX.	UNIT	TEST CONDITION
Average Luminous Intensity	I <sub>v</sub>	10	25		mcd	I <sub>F</sub> =60mA
Peak Emission Wavelength	λ <sub>p</sub>		585		nm	I <sub>F</sub> =20mA
Spectral Line Half-Width	Δ0λ		35		nm	I <sub>F</sub> =20mA
Dominant Wavelength	λ <sub>d</sub>		588		nm	I <sub>F</sub> =20mA
Forward Voltage Per Segment	V <sub>F</sub>		2.1	2.6	V	I <sub>F</sub> =20mA
Reverse Current Per Segment	I <sub>R</sub>			100	μA	V <sub>R</sub> =5V
Luminous Intensity Matching Ratio	I <sub>v</sub> -m			2:1		I <sub>F</sub> =10mA

Note: Luminous intensity is measured with a light sensor and filter combination that approximates the CIE (Commision Internationale De L'Eclairage) eye-response curve.

**TYPICAL ELECTRICAL / OPTICAL CHARACTERISTIC CURVES**

(25°C Ambient Temperature Unless Otherwise Noted)

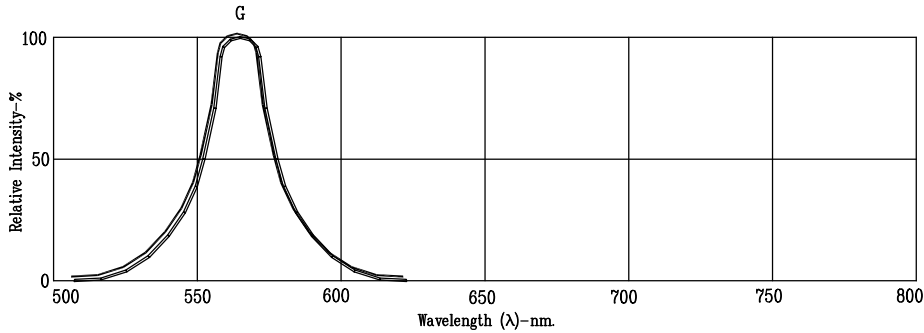

Fig.1. RELATIVE INTENSITY VS. WAVELENGTH

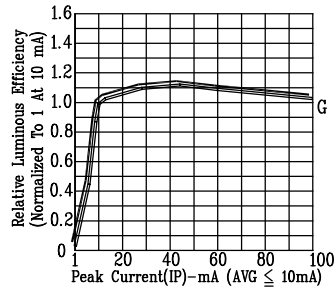

Fig.2. RELATIVE LUMINOUS EFFICIENCY (LUMINOUS INTENSITY PER UNIT CURRENT) VS. PEAK CURRENT (REFRESH RATE 1KHz)

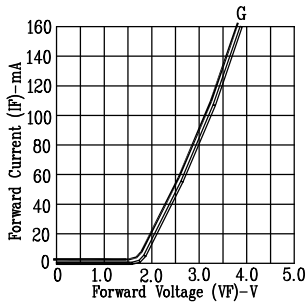

Fig.3. FORWARD CURRENT VS. FORWARD VOLTAGE

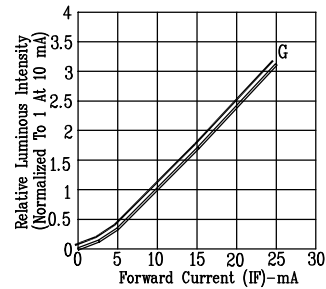

Fig.4. RELATIVE LUMINOUS INTENSITY VS. FORWARD CURRENT

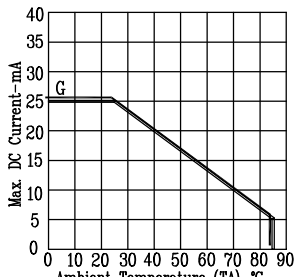

Fig.5. MAX. ALLOWABLE DC CURRENT VS. AMBIENT TEMPERATURE.

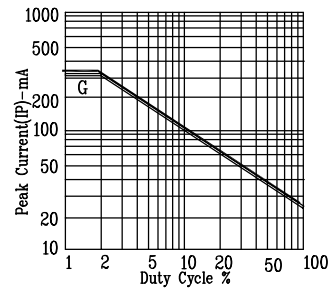

Fig.6. MAX. PEAK CURRENT VS. DUTY CYCLE % (REFRESH RATE 1KHz)

NOTE: G=GREEN