

ISOLATED DC/DC CONVERTERS

36 Vdc - 75 Vdc Input, 3.3 Vdc/25 A Output



Sep. 22, 2009

Bel Power, Inc., a subsidiary of Bel Fuse, Inc.

0REB-C0T03x RoHS Compliant PRELIMINARY Rev.A

Features

- Isolated
- High Efficiency
- Fixed Frequency (310 KHz)
- High Power Density
- Low Cost
- Remote On/Off
- Class 1, Category 2, Isolated DC/DC Converter (refer to IPC-9592)
- TUV EN60950-1 Recognized (Pending)
- UL60950-1 Recognized (UL/cUL) (Pending)
- Input Under Voltage Protection
- Output Voltage Trim
- Output Over-Voltage Protection
- OCP/SCP
- Over Temperature Protection

Applications

- Networking
- Computers and peripherals
- Telecommunications

Description

The 0REB-C0T03x is an isolated dc/dc converter that operates from a nominal 48 Vdc source. This converter provides up to 82 W of output power. Features include remote on/off, short circuit protection, over current protection, over-temperature protection, output over-voltage protection, input under-voltage protection.

Part Selection

Output Voltage	Input Voltage	Max. Output Current	Max. Output Power	Typical Efficiency	Model Number Active Low	Model Number Active High
3.3 Vdc	36 Vdc - 75 Vdc	25 A	82 W	92%	0REB-C0T03L	0REB-C0T033

Notes: Add "G" suffix at the end of the model number to indicate Tray Packaging.

Part Number Explanation

0 R EB - C0 T 03 L
1 2 3 4 5 6 7

- 1---Through hole mount
- 2---RoHS 6, change "R" to "7" means RoHS 5
- 3---Series name
- 4---Series code
- 5---Input range (36-75V)
- 6---Output voltage (3.3V)
- 7---Enable, active low, change "L" to "3" means active high

ISOLATED DC/DC CONVERTERS

36 Vdc - 75 Vdc Input, 3.3 Vdc/25 A Output



Sep. 22, 2009

Bel Power, Inc., a subsidiary of Bel Fuse, Inc.

Absolute Maximum Ratings

Parameter	Min	Typ	Max	Unit	Notes
Continuous non-operating Input Voltage	-0.3	-	75	V	
Input Transient Voltage	-	-	100	V	100mS maximum
Remote On/Off	-0.3	-	18	V	
I/O isolation voltage	-	-	1500	V	
Ambient Temperature	-40	-	85	°C	
Storage Temperature	-55	-	125	°C	

Note: Ratings used beyond the maximum ratings may cause a reliability degradation of the converter or may permanently damage the device.

Input Specifications

Parameter	Min	Typ	Max	Unit	Notes
Operating Input Voltage	36	48	75	V	
Input Current (full load)	-	-	2.56	A	
Input Current (no load)	-	50	100	mA	
Remote Off Input Current	-	10	15	mA	
Input Reflected Ripple Current (rms)	-	2	5	mA	With simulated source impedance of 10uH, 5Hz to 20MHz. Use a 100uF/100V electrolytic capacitor with ESR=1 ohm max, at 200KHz@25°C.
Input Reflected Ripple Current (pk-pk)	-	20	40	mA	
I ² t Inrush Current Transient	-	-	1	A ² s	
Turn-on Voltage Threshold	32	34	35	V	
Turn-off Voltage Threshold	30	32	34	V	

CAUTION: This converter is not internally fused. An input line fuse must be used in application.

Recommend a fast-acting fuse with maximum rating of 3.5A on system board. Refer to the fuse manufacturer's datasheet for further information.

Notes: 1. This converter has internal C-L-C (0.47uF-2.2uH-3.2uF) filter.

2. All specifications are typical at 25 °C unless otherwise stated.

Output Specifications

Parameter	Min	Typ	Max	Unit	Notes
Output Voltage Set Point	3.25	3.3	3.35	V	Vin=48V, Io=50% load
Load Regulation	-	0.2	0.5	% Vo,set	Vin=48V, Io=0~100% load
Line Regulation	-	0.2	0.5	% Vo,set	Vin=36~75V, Io=100% load
Regulation Over Temperature (-40deg.C-85deg.C)	-	-	0.02	% Vo,set/C	
Ripple and Noise (pk-pk)	-	90	120	mV	Vin=48V, Io=100%load at 25oC ambient, 0-20MHz BW, with a 1µF ceramic capacitor and a 10uF Tantalum cap at output.
Ripple and Noise (rms)	-	25	40	mV	
Ripple and Noise (pk-pk) under worst case	-	-	160	mV	over all operating input voltage, load and ambient temperature condition

ISOLATED DC/DC CONVERTERS

36 Vdc - 75 Vdc Input, 3.3 Vdc/25 A Output



Sep. 22, 2009

Bel Power, Inc., a subsidiary of Bel Fuse, Inc.

Output Specifications (continued)

Parameter	Min	Typ	Max	Unit	Notes	
Output Current Range	0	-	25	A		
Output DC Current Limit	28	31	36	A		
Short Circuit Surge Transient	-	-	TBD	A ² s		
Rise time	-	-	10	mS		
Turn on Time	-	10	20	mS		
	-	10	20	mS		
Overshoot at Turn on	-	0	3	%		
Output Capacitance	0	-	10000	uF		
Transient Response						
ΔV 50%~75% of Max Load	Overshoot	-	100	150	mV	di/dt=0.1A/us, Vin=48Vdc, Ta=25°C, with a 1μF ceramic capacitor and a 10uF Tantalum cap at output.
	Settling Time	-	200	400	uS	
ΔV 75%~50% of Max Load	Overshoot	-	100	150	mV	
	Settling Time	-	200	400	uS	

Note: All specifications are typical at nominal input, full load at 25°C unless otherwise stated.

General Specifications

Parameter	Min	Typ	Max	Unit	Notes
Efficiency	90	92	-	%	Vin=48V, full load
Switching Frequency	290	310	330	kHz	
Over Temperature Protection	-	110	120	°C	
Output Voltage Trim Range	80	-	110	%	
Over Voltage Protection(Static)	3.8	-	5	V	This voltage is achieved by trimming up output slowly.
Over Voltage Protection (Dynamic)	-	-	5	V	The transient over voltage is achieved by connecting the Trim pin to Vout+ pin through a 1K resistor.
Input to Output	-	-	1500	V	
Isolation Resistance	10M	-	-	Ohm	
Isolation Capacitance	-	2200	-	pF	
Weight	-	23	-	g	
FIT		350		-	Calculated Per Bell Core SR-332 (Vin=48V, Vo=3.3V, Io=20A, Ta = 25 °C, FIT=10 ⁹ /MTBF)
Dimensions					
Inches (L x W x H)		2.30 x 0.90 x 0.334		-	
Millimeters (L x W x H)		58.42 x 22.86 x 8.50			

Note: All specifications are typical at 25 °C unless otherwise stated.

ISOLATED DC/DC CONVERTERS

36 Vdc - 75 Vdc Input, 3.3 Vdc/25 A Output



Sep. 22, 2009

Bel Power, Inc., a subsidiary of Bel Fuse, Inc.

Efficiency Data

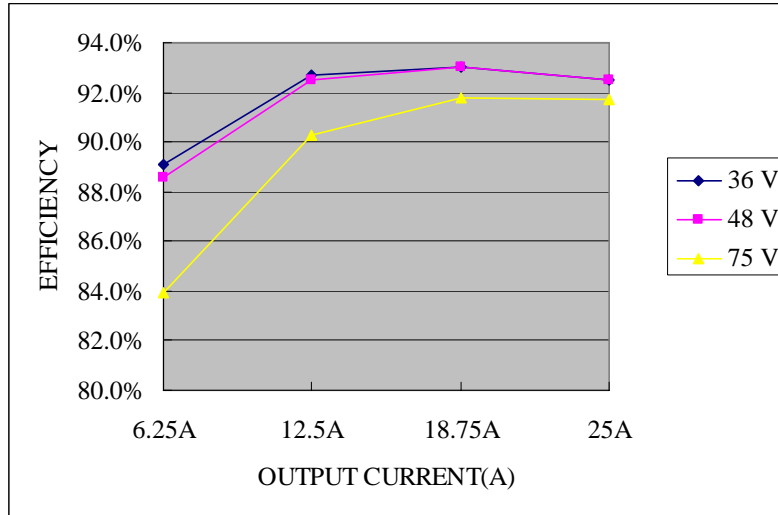

Thermal Derating Curve

Maximum junction temperature of semiconductors derated to 120 degree C.

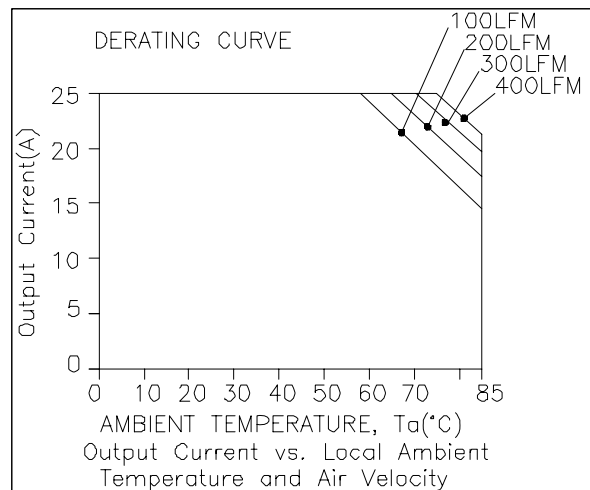
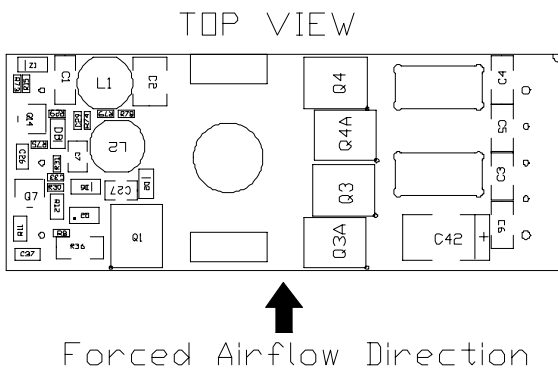

Derating curve under normal input

ISOLATED DC/DC CONVERTERS

36 Vdc - 75 Vdc Input, 3.3 Vdc/25 A Output



Sep. 22, 2009

Bel Power, Inc., a subsidiary of Bel Fuse, Inc.

Thermal Derating Curve (continued)

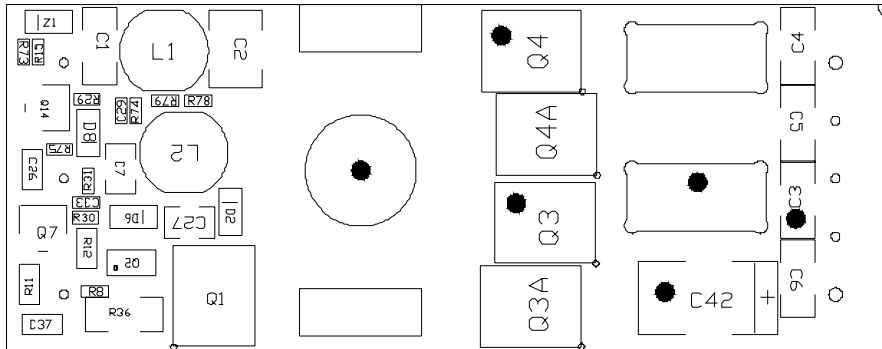

Temperature reference points on top side

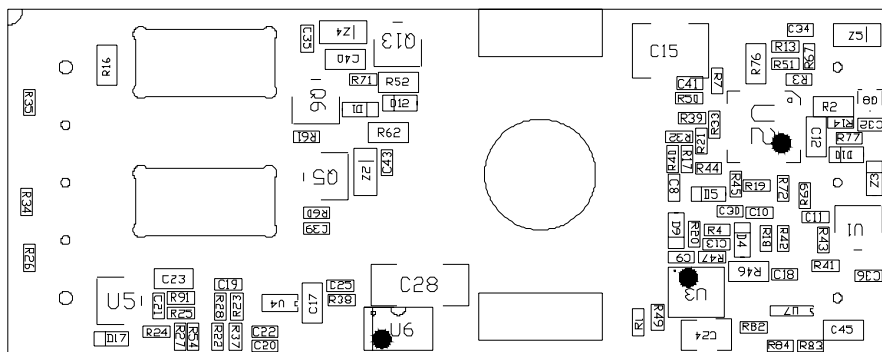

Temperature reference points on bottom side

Ripple and Noise Waveform

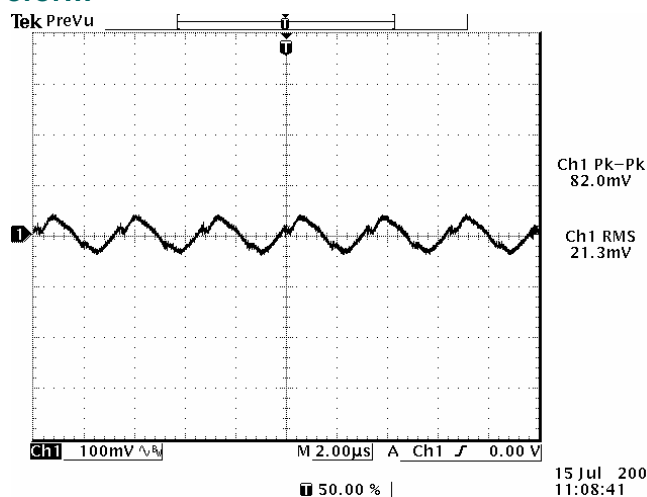

48Vdc input, 3.3Vdc/25A output

Note: Ripple and noise at full load, with a 1uF ceramic cap and a 10 uF Tantalum cap at output, Ta=25 deg C.

ISOLATED DC/DC CONVERTERS

36 Vdc - 75 Vdc Input, 3.3 Vdc/25 A Output



Sep. 22, 2009

Bel Power, Inc., a subsidiary of Bel Fuse, Inc.

Transient Response Waveforms

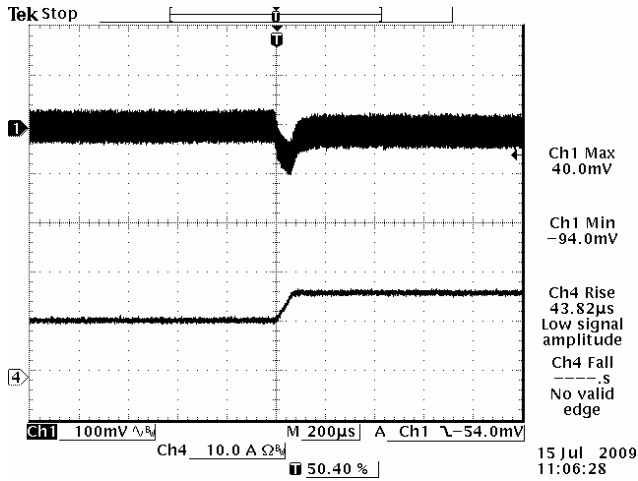

Vout= 3.3V 50%-75% Load Transients

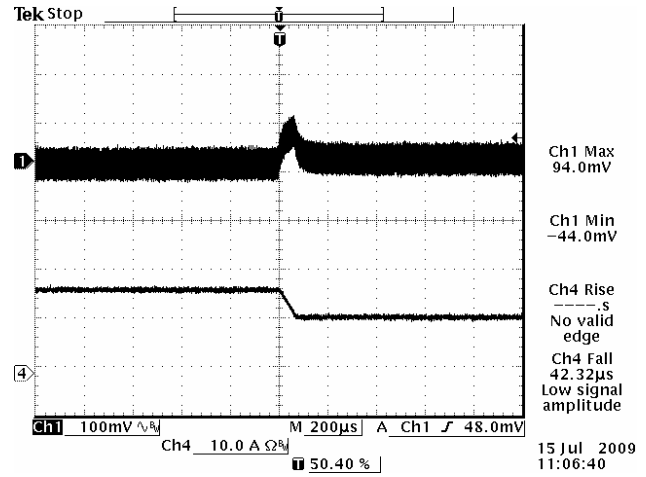

Vout= 3.3V 75%-50% Load Transients

Note: Transient Response at Vin=48V, di/dt=0.1A/uS, with a 1uF ceramic cap and a 10uF aluminum cap at the output.

Startup & Shutdown

Rise Time

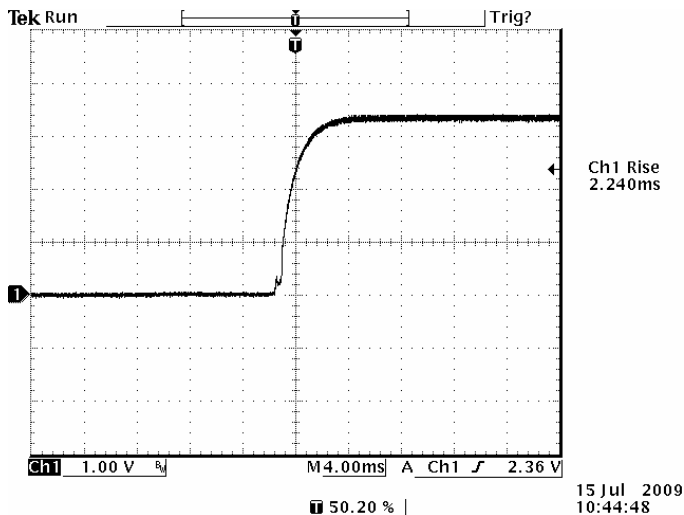

Vin=48V, Vo=3.3V, Io=25A

ISOLATED DC/DC CONVERTERS

36 Vdc - 75 Vdc Input, 3.3 Vdc/25 A Output



Sep. 22, 2009

Bel Power, Inc., a subsidiary of Bel Fuse, Inc.

Startup & Shutdown (continued)

Startup time

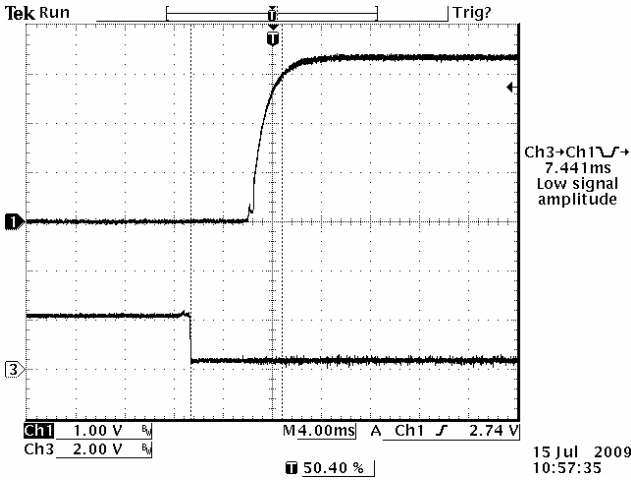

Startup from Vin
Ch1: Vo
Ch3: Vin
Vin=48V, Vo=3.3V, Io=25A

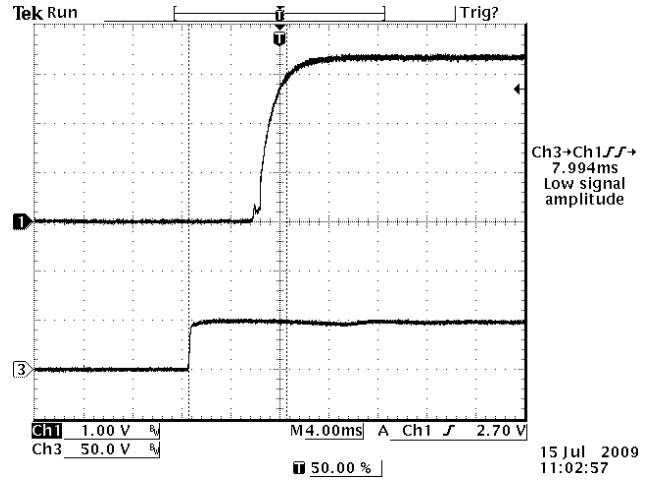

Startup from on/off
Ch1: Vo
Ch3: on/off
Vin=48V, Vo=3.3V, Io=25A

Shutdown

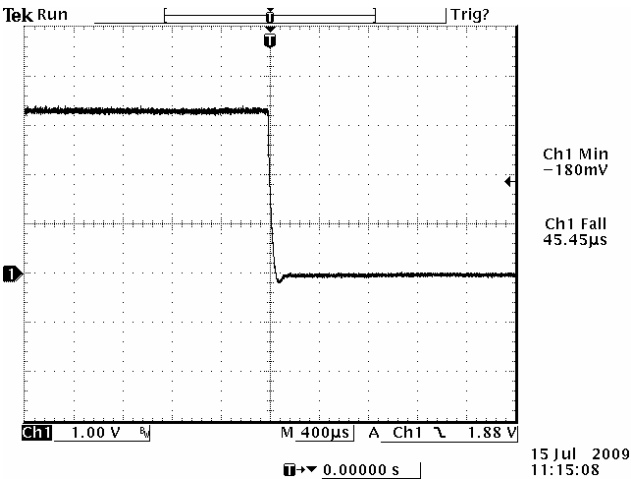

Vin=48V, Vo=3.3V, Io=25A

ISOLATED DC/DC CONVERTERS

36 Vdc - 75 Vdc Input, 3.3 Vdc/25 A Output



Sep. 22, 2009

Bel Power, Inc., a subsidiary of Bel Fuse, Inc.

Remote On/Off

Parameter		Min	Typ	Max	Unit	Notes
Signal Low (Unit On)	Active Low	-0.3	-	0.8	V	The remote on/off pin open, Unit off.
Signal High (Unit Off)		2.4	-	18	V	
Signal Low (Unit Off)	Active High	-0.3	-	0.8	V	The remote on/off pin open, Unit on.
Signal High (Unit On)		2.4	-	18	V	
Current Sink		0	-	1	mA	

Recommended remote on/off circuit for active low

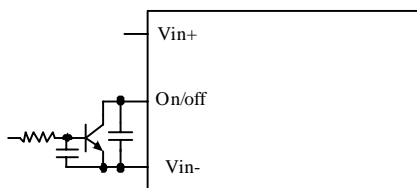

Control with open collector/drain circuit

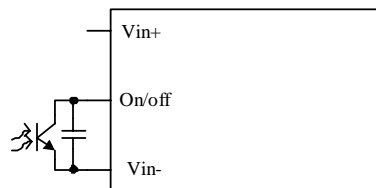

Control with photocoupler circuit

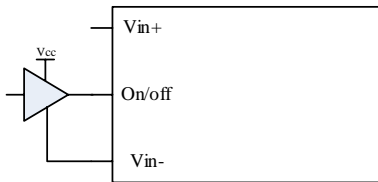

Control with logic circuit

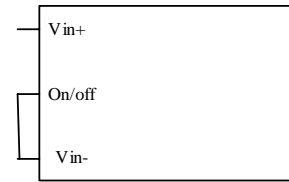

Permanently on

Recommended remote on/off circuit for active high

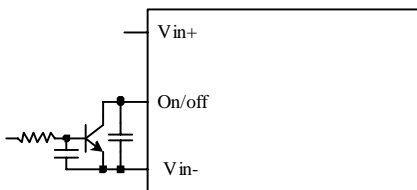

Control with open collector/drain circuit

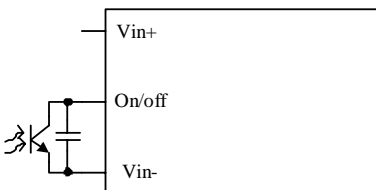

Control with photocoupler circuit

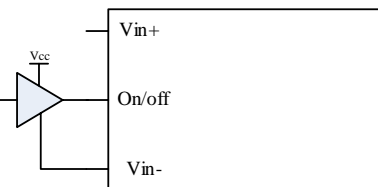

Control with logic circuit

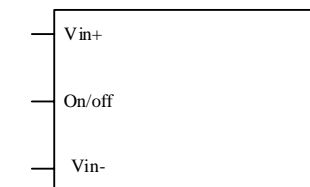

Permanently on

ISOLATED DC/DC CONVERTERS

36 Vdc - 75 Vdc Input, 3.3 Vdc/25 A Output



Sep. 22, 2009

Bel Power, Inc., a subsidiary of Bel Fuse, Inc.

Output Trim Equations

Equations for calculating the trim resistor are shown below. The Trim Down resistor should be connected between the Trim pin and Sense (-) pin. The Trim Up resistor should be connected between the Trim pin and the Sense (+). Only one of the resistors should be used for any given application.

Minimum trim down voltage is 2.64V

Maximum trim up voltage is 3.63V.

The total voltage increased by trim and remote sense should not exceed 10% of the nominal output voltage.

$$R_{trimdown} = \frac{511}{\Delta\%} - 10.22 [k\Omega]$$

$$R_{trimup} = \frac{5.11 \times V_o \times (100 + \Delta\%) - 626}{1.225 \times \Delta\%} - 10.22 [k\Omega]$$

Note:
$$\Delta\% = \left| \frac{V_{DES} - V_o}{V_o} \right| \times 100$$

V_{o_req} = Desired (trimmed) output voltage [V]

Output voltage V_o = 3.3 V

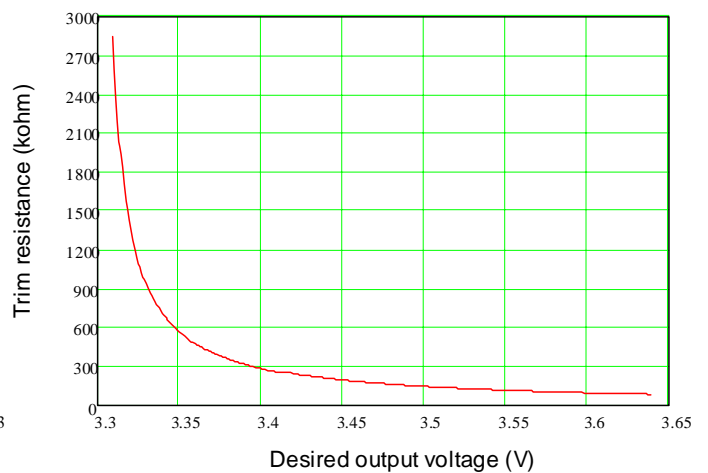
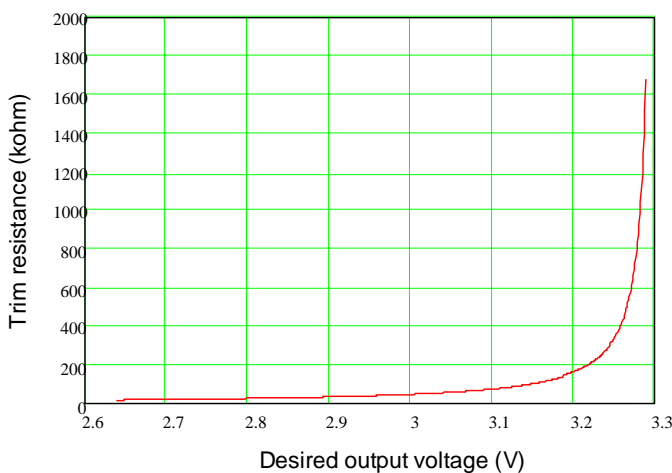
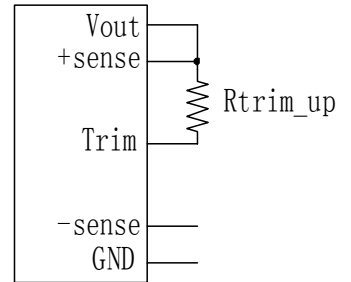
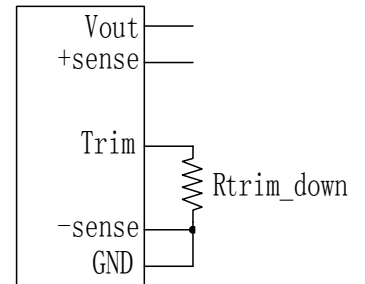

ISOLATED DC/DC CONVERTERS

36 Vdc - 75 Vdc Input,

3.3 Vdc/25 A Output

bel

Sep. 22, 2009

Bel Power, Inc., a subsidiary of Bel Fuse, Inc.

Remote Sense

This module has remote sense compensation feature. It can minimize the effects of resistance between module's output and load in system layout and facilitates accurate voltage regulation at load terminals or other selected point.

1. The remote sense lines carries very little current and hence do not require a large cross-sectional area.
2. This module compensates for a maximum drop of 10% of the nominal output voltage.
3. If the unit is already trimmed up, the available remote sense compensation range should be correspondingly reduced. The total voltage increased by trim and remote sense should not exceed 10% of the nominal output voltage.
4. When using remote sense compensation, all the resistance, parasitic inductance and capacitance of the system are incorporated within the feedback loop of this module. It can make an effect on the module's compensation, affecting the stability and dynamic response. A 0.1uF ceramic capacitor can be connected at the point of load to de-couple noise on the sense wires.
5. Recommend the connection of remote sense compensation as below figure. There are a resistor RS+ (10 ohm) from Vo+ to Sense+ and a resistor RS- (10 ohm) from Vo- to Sense- inside of this module.

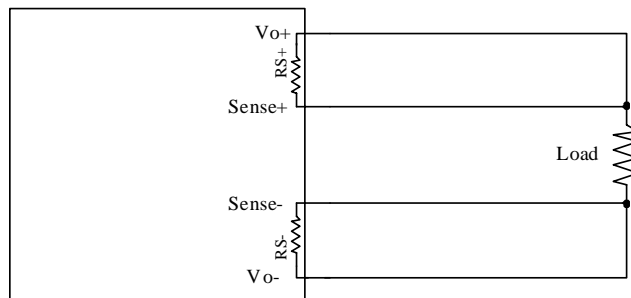

6. If not using remote sense compensation, please connect sense directly to output at module's pin, that is, connect sense+ to Vo+ and sense- to Vo- at module's pin, the shorter the better. See below figure.

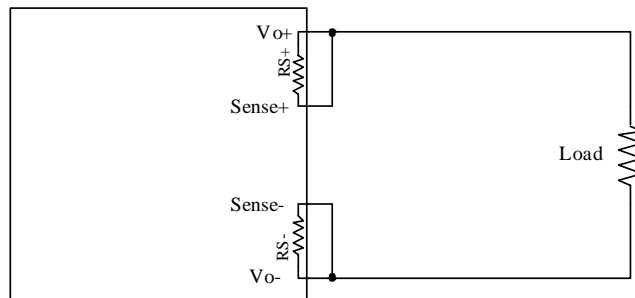

ISOLATED DC/DC CONVERTERS

36 Vdc - 75 Vdc Input, 3.3 Vdc/25 A Output



Sep. 22, 2009

Bel Power, Inc., a subsidiary of Bel Fuse, Inc.

Over Current Protection

To provide protection in a fault output overload condition, the module is equipped with internal current-limiting circuitry and can endure current limiting for a few milli-seconds. If the over current condition persists beyond a few milliseconds, the module will shut down into hiccup mode and restart once every 700mS. The module operates normally when the output current goes into specified range. The typical average output current is 2A during hiccup.

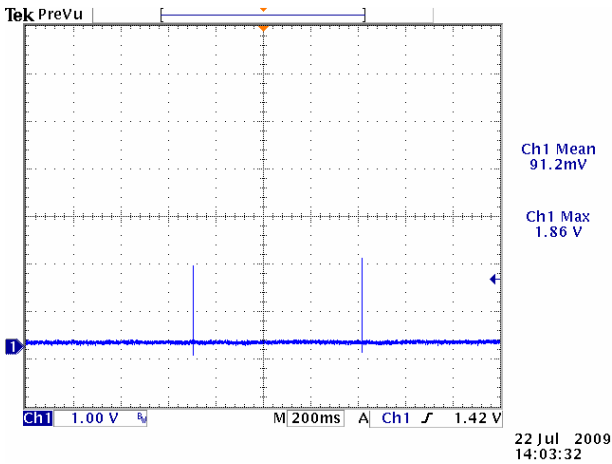

Vin=48V

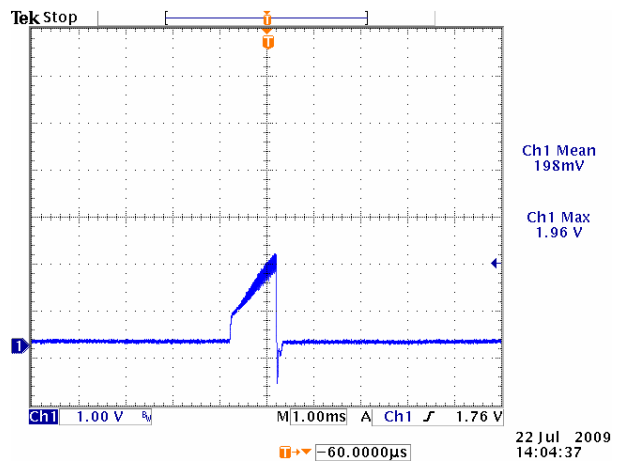

Expansion of on time portion

Over Voltage Protection

The output over voltage protection consists of circuitry that monitors the voltage on the output terminals. If the voltage on the output terminals exceeds the over voltage protection threshold, the module will shutdown into hiccup mode and restart once every 700mS. The module operates normally when the fault is cleared.

Test setup:

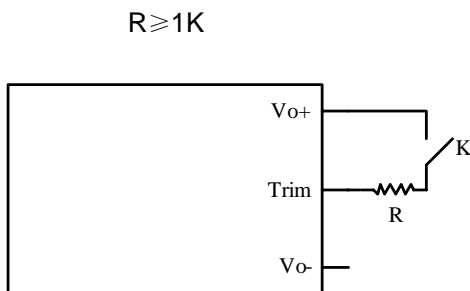

Waveform:

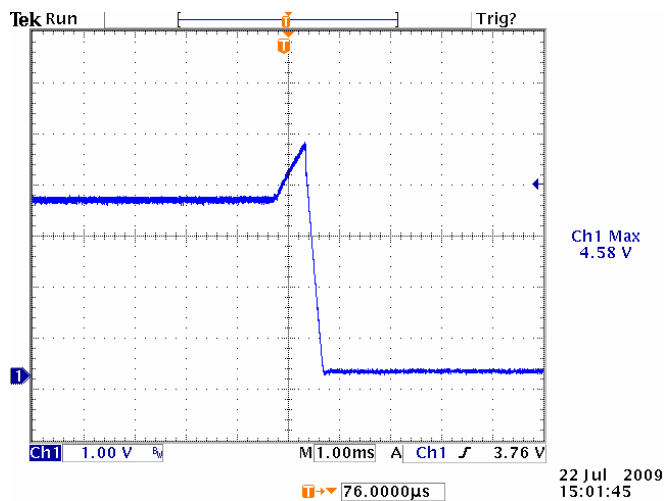

ISOLATED DC/DC CONVERTERS

36 Vdc - 75 Vdc Input, 3.3 Vdc/25 A Output



Sep. 22, 2009

Bel Power, Inc., a subsidiary of Bel Fuse, Inc.

Over Temperature Protection

The OTP is achieved by thermistor R12 and the threshold is set at 110C in non-latch mode; the hottest component Q1 reaches 112C with 100LFM air flow correspondingly. It will restart automatically when the temperature falls down to 100C. The protecting point will be varied a little under different conditions (air flow, ambient temperature, input voltage, load...).

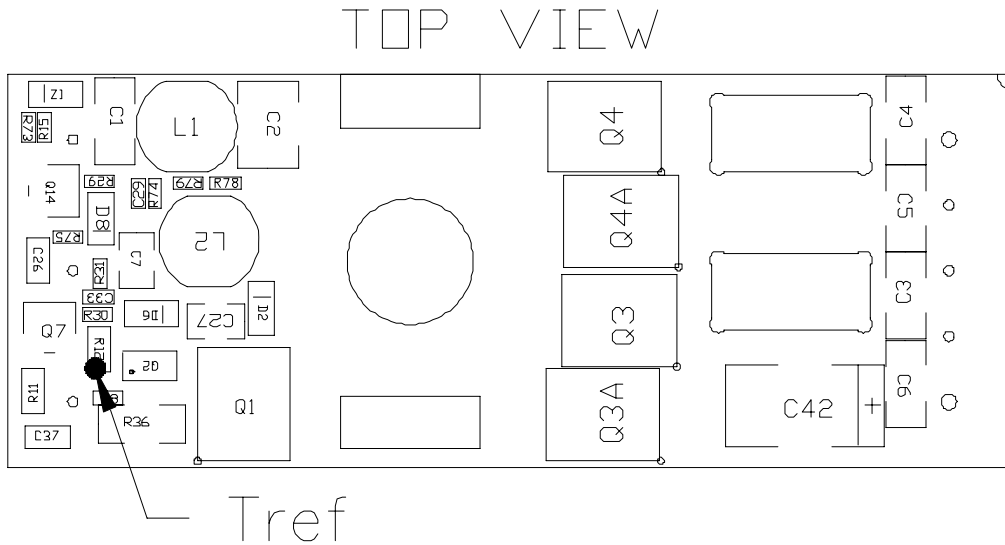

Input Under-voltage Lockout

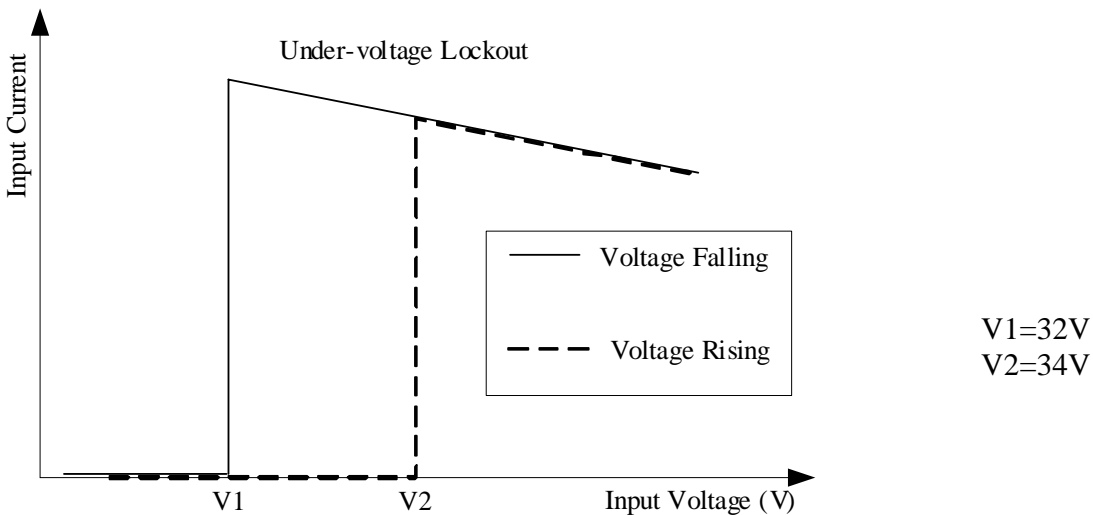

ISOLATED DC/DC CONVERTERS

36 Vdc - 75 Vdc Input, 3.3 Vdc/25 A Output



Sep. 22, 2009

Bel Power, Inc., a subsidiary of Bel Fuse, Inc.

Safety & EMC

Safety

1. Material flammability UL94V-0
2. TUV Certification EN60950-1
3. UL Certification UL60950-1

EMC

1. Surge IEC61000-4-5
2. DC-DIP IEC61000-4-29
3. Conductive EMI EN55022 class A

Compliance to EN55022 class A (both q.peak and average) with the following inductive and capacitive filter

Setup:

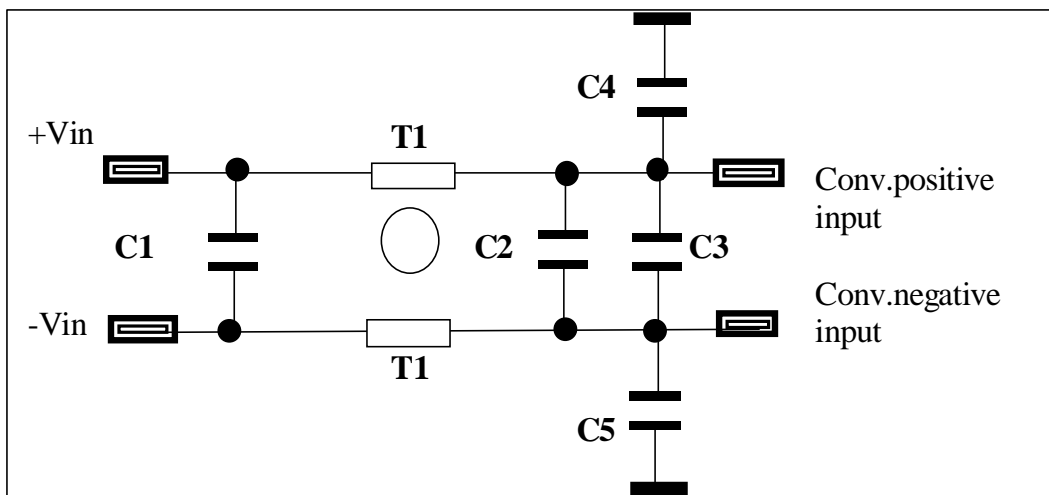

Item	Designator	Parameter	Vendor	Vendor P/N
1	C1	1uF/100V,ceramic	Murata	GRM32ER72A105KA01L
2	C2	0.1uF/100V, ceramic	TDK	C3216X7R2A104K
3	C3	100uF/100V, AL cap	Nichicon	UVZ2A101MPD
4	C4	22nF/1000V,ceramic	Johanson	631S41W223KV4E
5	C5	22nF/1000V,ceramic	Johanson	631S41W223KV4E
6	T1	1.3mH, common mode	Pulse	P0402NL

ISOLATED DC/DC CONVERTERS

36 Vdc - 75 Vdc Input, 3.3 Vdc/25 A Output



Sep. 22, 2009

Bel Power, Inc., a subsidiary of Bel Fuse, Inc.

Safety & EMC (continued)

Positive

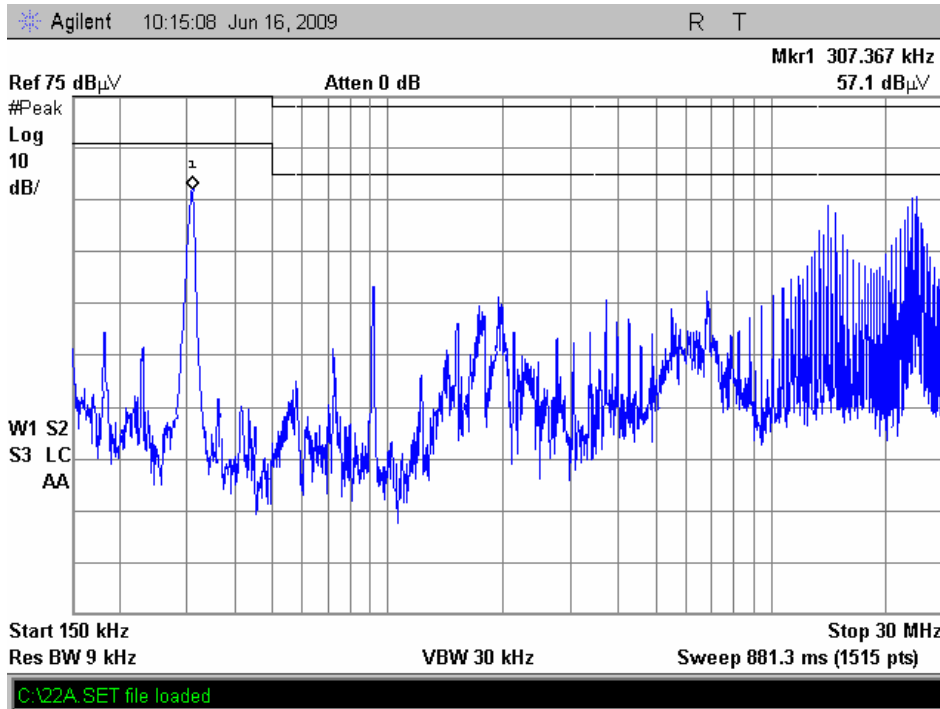

Negative

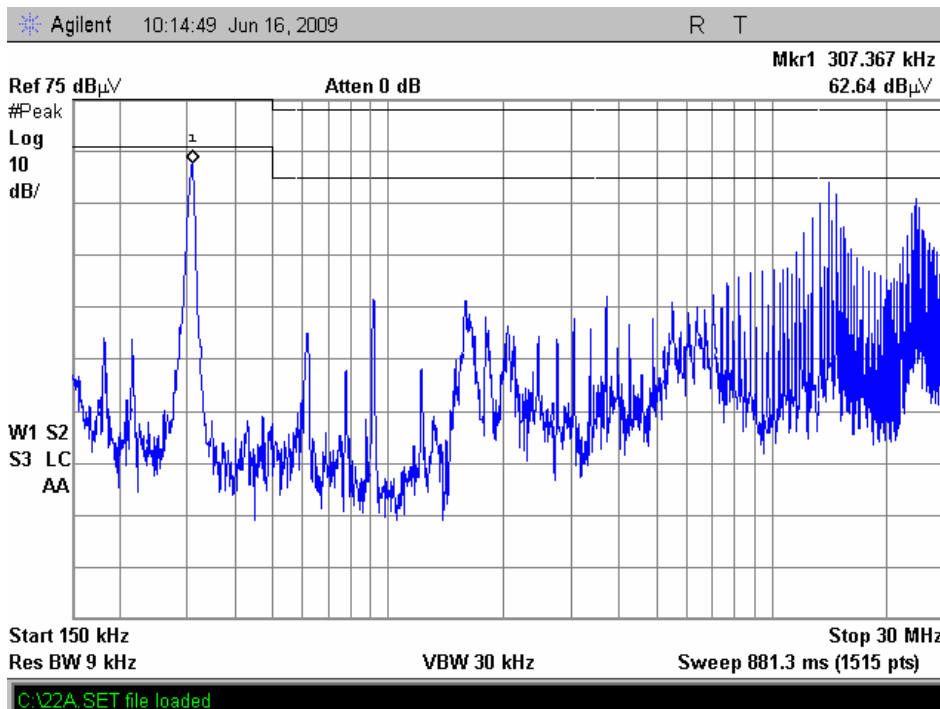

ISOLATED DC/DC CONVERTERS

36 Vdc - 75 Vdc Input, 3.3 Vdc/25 A Output



Sep. 22, 2009

Bel Power, Inc., a subsidiary of Bel Fuse, Inc.

Mechanical Outline

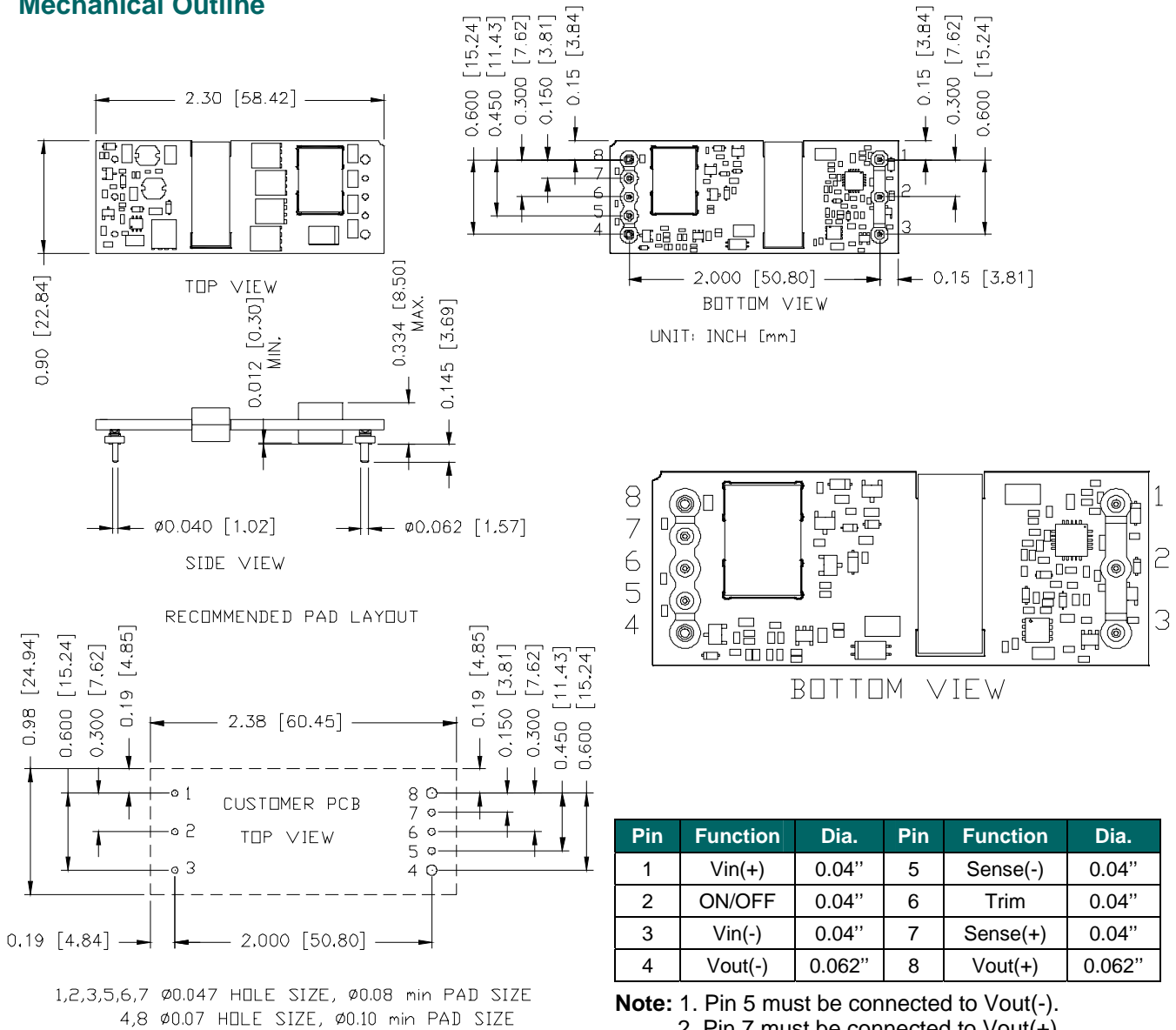

Note: This module is recommended and compatible with Pb-Free Wave Soldering and must be soldered using a peak solder temperature of no more than 260 °C for less than 5 seconds.

Note:

- 1) All Pins: Material - Copper Alloy;
Finish – 3 micro inches minimum Gold over 50 micro inches minimum Nickel plate.
- 2) Undimensioned components are shown for visual reference only.
- 3) All dimensions in inches (mm); Tolerances: x.xx +/-0.02 in. (x.x +/-0.5mm) x.xxx +/-0.010 in. (x.xx +/-0.25mm).

ISOLATED DC/DC CONVERTERS

36 Vdc - 75 Vdc Input, 3.3 Vdc/25 A Output



Sep. 22, 2009

Bel Power, Inc. , a subsidiary of Bel Fuse, Inc.

Revision History

Date	Revision	Changes Detail	Approval
2009-9-22	A	First release	YP Zhou

RoHS Compliance

Complies with the European Directive 2002/95/EC, calling for the elimination of lead and other hazardous substances from electronic products.



©2009 Bel Fuse Inc. Specifications subject to change without notice. 092209

16

CORPORATE

Bel Fuse Inc.
206 Van Vorst Street
Jersey City, NJ 07302
Tel 201-432-0463
Fax 201-432-9542
www.belfuse.com

FAR EAST

Bel Fuse Ltd.
8F/ 8 Luk Hop Street
San Po Kong
Kowloon, Hong Kong
Tel 852-2328-5515
Fax 852-2352-3706
www.belfuse.com

EUROPE

Bel Fuse Europe Ltd.
Preston Technology Management Centre
Marsh Lane, Suite G7, Preston
Lancashire, PR1 8UD, U.K.
Tel 44-1772-556601
Fax 44-1772-888366
www.belfuse.com