

THIS DOCUMENT IS THE PROPERTY OF
KEYSTONE ELECTRONICS CORP. AND
SHALL NOT BE REPRODUCED, DISTRIBUTED
OR USED AS A BASIS FOR MANUFACTURE
WITHOUT PRIOR WRITTEN PERMISSION
FROM KEYSTONE ELECTRONICS CORP.

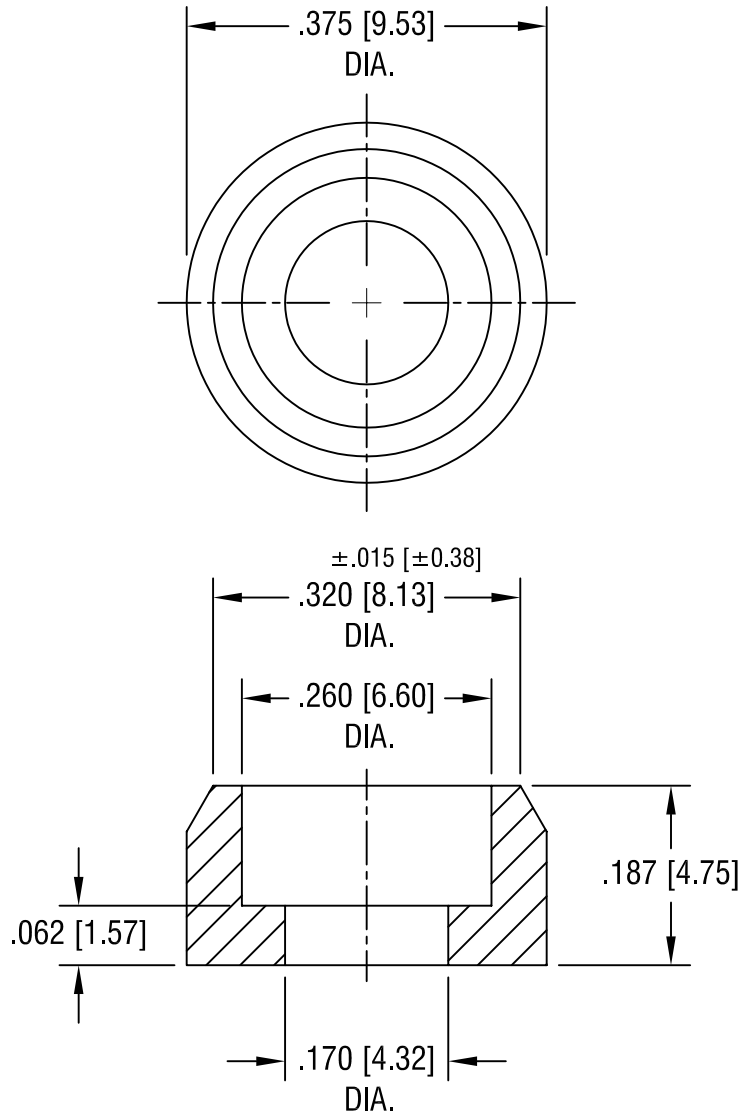

KEYSTONE ELECTRONICS CORP.

ASTORIA, N.Y. 11105-2017

PART NAME

FERRULE

MATERIAL

BRASS

FINISH

NICKEL PLATE

DRN BY

BOONE

DATE

11.28.95

APPD

LN

SCALE

5X

TOLERANCES

INCH [MM]

DECIMAL ±.005 [±0.15]

ANGULAR ± 1°

UNLESS OTHERWISE SPECIFIED

CODE

C

DWG NO.

7163

DATE

DESCRIPTION

REV.